

FORGEMART INDIA PVT LTD

RESOURCES OF REFRACTORY & CONSUMABLE PRODUCTS



WE ARE SUPPLIER & EXPORTER OF CCM SPARES, REFRACTORY AND HYDRAULIC SLIDE GATE SYSTEM TYPE 1QC & 2QC



www.forgemart.com



Forgemart®

RESOURCES OF REFRACTORY & CONSUMABLE PRODUCTS

About Us

“Forgemart India Private Limited” is one of the leading manufacturers, suppliers and exporters of a wide range, high quality and reasonable price of QC Slide Gate Systems, CCM Spares, Refractory and Consumable Products used in steel plants. We provide complete Continuous Casting technology Solution, spare parts fabrication, erection and commissioning services.

we have developed a well equipped manufacturing facility, which helps us in maintaining continuous production to meet the needs of the market. We fabricate all the products using high grade raw material and latest technology to assure that final output meets high quality standards & norms.

We have established a strong foothold in the market. Our business acumen, client centric approach enabled us to garner a huge client base in India and overseas.



Our Mission

We welcome our new and old customers and closely interact with them for their current requirement and also future businesses and maintain better relationship.

To provide superior quality and lowest price to our customers in India and elsewhere in the world. The ultimate goal of Forgemart is to have its own identity in the Steel Equipment service industry as trusted, high quality, time bound and cost effective service provider .

Forgemart is committed to maintain 100% client’s satisfaction by certain values:

- Deep Integrity & Ensuring Code of Conduct
- Timekeeping & Highest level of Accuracy
- Potential Leadership with an Energetic Team
- Sufficient Infrastructure for Expansion
- Continuous Growth and innovation

OUR MAIN MOTO

- Quality Assurance
- Competitive Prices
- Timely Delivery
- Customer Satisfaction

OUR PRODUCTS & SERVICES

- QC Slide Gate Systems
- Refractory Products
- CCM Spare Parts
- Consumable Products
- Furnace & Rolling Mills

Clientele

We are a customer-oriented organization, in which all endeavors are directed towards achieving utmost client satisfaction. For this purpose, we provide our clients a comprehensive range of Refractory & Consumable Products. We use latest technology and high grade raw material, sourced from the trustworthy vendors. All such measures have helped us in winning the confidence and support from our clientele. The list herein includes well known steel manufactures in India and overseas.



QC Slide Gate Systems

The ladle slide gate system is a critical piece of flow control equipment in liquid steel casting. The service life of the slide gate plate is a limiting factor to achieve performance and is greatly dependent on the type of slide gate mechanism used. A new generation slide gate system is the key to achieving longer plate service life and hence higher productivity and more economical operation.

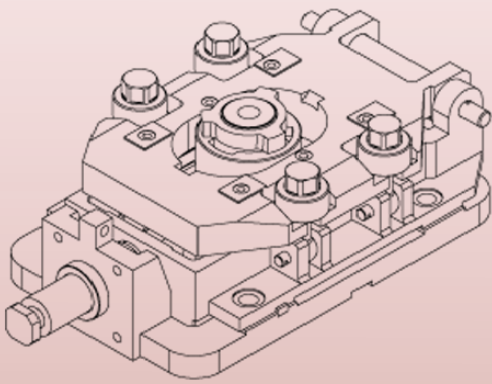

Forgemart India Private Limited is manufacturer and Sellers of Ladle QC Slide Gate System with all spares parts for both systems QC1 and QC2. Moreover we have manufactured these products using high grade Raw Material.

With a wide range, high quality, reasonable price and stylish designs, our products are extensively used in steel industries.

Our products are widely recognized and accepted by our clients and continuously upgraded to suit their needs.

OUR PRODUCTS

- Complete Slide Gate System type 1QC & 2QC
- Adaptor frame
- Housing & Housing Cover
- Fixed Plate Polder
- Slider
- Cylinder bracket
- Eyebolts and Expansion Compensating Nuts
- Extension Rod
- Nozzle holder
- Centering Ring
- Eccentric Clamping Device etc.

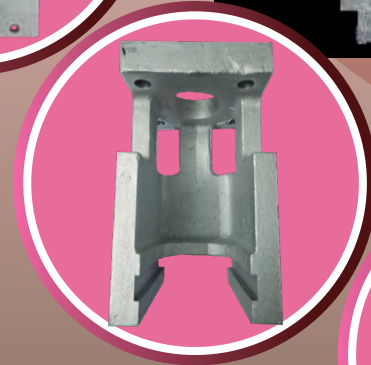
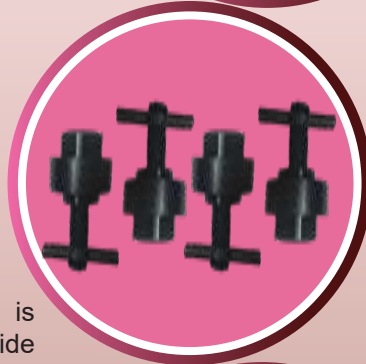
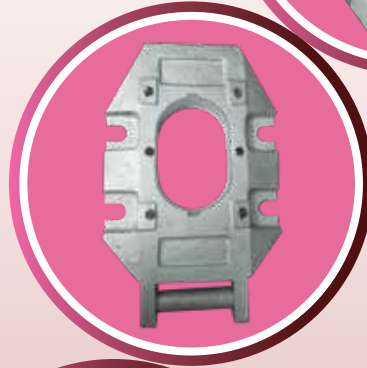
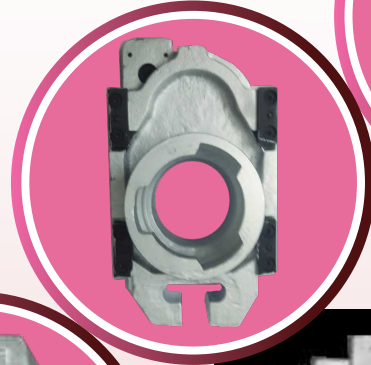
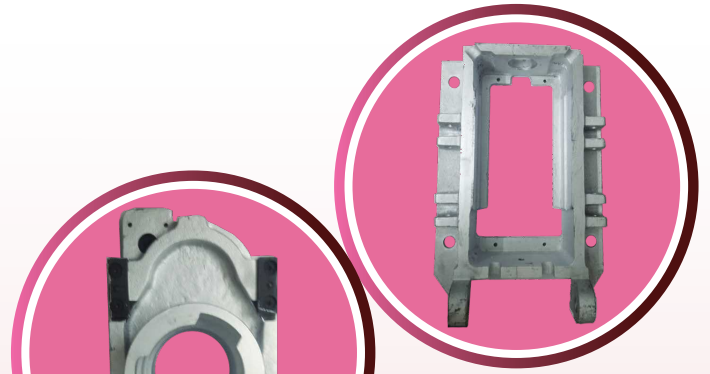



Continuous Casting Machine (CCM)

Continuous casting is the process whereby a molten metal solidifies into continuous forms of strips and billets that can be further worked upon in the finishing mills. These “semi finished” billet, bloom, or slabs are casted by using open ended mold and water spray technique. The continuous casting process was developed only in 1950, before that steel was poured into a stationary mold to form ‘ingots’.

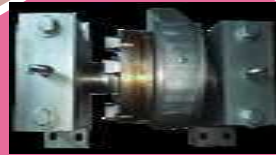
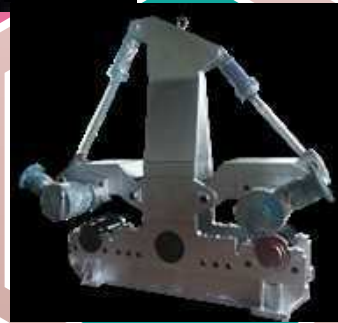
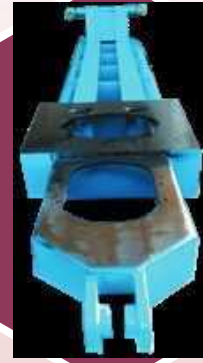

Forgemart India Private Limited is manufacturer, supplier and exporter of a wide collection of Continuous Casting Machine (CCM) spare parts. Our products range are:

- Straightener Unit
- Mould Jacket
- Aluminum Template
- Tundish
- Ladle
- Rigid Dummy Bar
- RT Roller
- Spray Pipe
- Shearing Blade
- Mould Oscillation Arm
- Cam Assembly
- Apron Assembly
- Tundish Car
- Flexible Dummy Bar
- Inner Casing
- Pusher Assembly
- Billet Shearing Machine
- Withdrawal Roller etc.

In addition to this, we also provide Continuous Casting Solutions and Fabrication & Erection Services to our customers for fulfilling their exact requirements.



Refractory Products

Refractories are heat-resistant materials that constitute the linings for high-temperature furnaces and reactors and other processing units. They play a triple role of providing mechanical strength, protection against corrosion and thermal insulation. They need to resist all types of stresses (mechanical, thermal and chemical) encountered at high level temperatures, such as fusion, erosion, creep deformation, corrosion and thermal shock.

Forgemart India Private Limited are supplier and exporter of a wide collection of Refractory products for CCM & Furnace use. Our refractory products range are:

- Tundish Board
- Tundish Nozzle
- Tundish well block
- Slide Gate Plate
- Collector Nozzle
- Fire Bricks
- High Alumina Bricks
- Insulation Brick
- Porous Plug
- NFC
- Mortar
- Castable
- Ramming Mass
- Gunning Mass
- Radex Powder
- Calcium Silicate





Forgemart®

RESOURCES OF REFRACTORY & CONSUMABLE PRODUCTS

Consumable Products

Forgemart India Private Limited are supplier and exporter of a wide collection of Consumable Products for Steel Industries. Our consumable products range are:

- Lancing Pipe
- Spray Nozzle
- Valves
- Gear Box & Motor
- Coupling
- Hydraulic Cylinder
- Popular Shaft
- Bearing
- Cutting Torch
- Air Below
- CI & Copper Plug
- Safety Equipments
- Hydraulic Pipe
- Flanges
- Asbestos Rope
- Hose Pipe
- Spray Pipe
- Seal Kit
- Silicon 'O' Ring
- Dummy Bar Bolt
- Hydraulic Valves
- Wire Rope etc

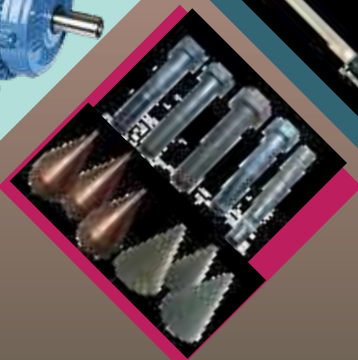
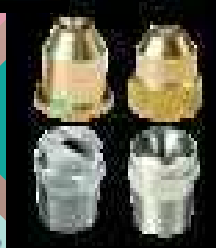
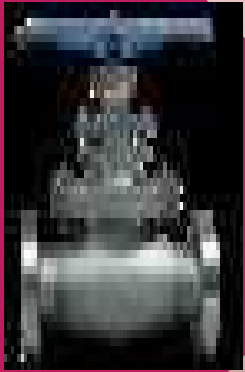



Forgemart[®]

RESOURCES OF REFRACTORY & CONSUMABLE PRODUCTS

Contact Us



M. B. Ahmad (Director)



+91 8879685252



+91 9820415806



info@forgemart.com



Forgemart India Private Limited

B-37, 2nd Floor, Gami Industrial Park, Plot No. C-39A

MIDC Pawane, Navi Mumbai - 400 705, Maharashtra (India)

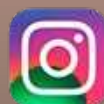

www.forgemart.com